



Compact Parada

GRZEJNIKI PŁYTOWE

KARTA KATALOGOWA



COMPACT PARADA

Grzejnik płytowy Compact Parada NG wyróżnia całkowicie płaska płyta czołowa o wyraźnym, minimalistycznym wzornictwie, która doskonale komponuje się z dopasowanymi osłonami bocznymi oraz pokrywą górną typu grill. Razem tworzą elegancki grzejnik, który z łatwością wkomponuje się do każdego stylu wykończenia pomieszczenia. Compact Parada NG z połączeniami bocznymi przeznaczony jest do systemów ogrzewania wodnego zarówno w nowych, jak i w modernizowanych obiektach.

dane techniczne

- W komplecie z grzejnikiem 2 lub 3 (dla dług. ≥ 1800) konsole SSMS wraz z kołkami i wkrętami, korek i odpowietrznik
- Uchwyty na tylnej ścianie
- Króćce podłączeniowe : 4 x GW 1/2"
- Kolory : w standardzie RAL 9016 (inne kolory str. 11)
- Akcesoria : patrz str. 9



rzuty z boku

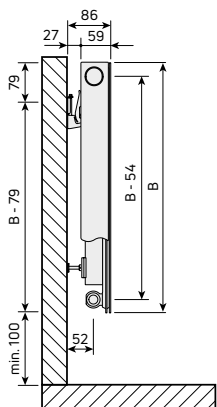

typ 11

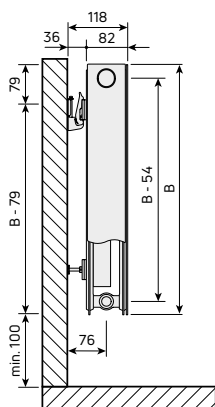

typ 21s

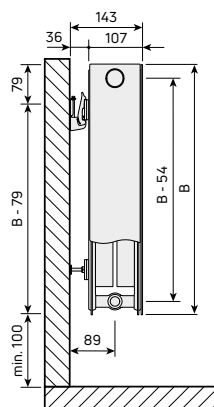

typ 22

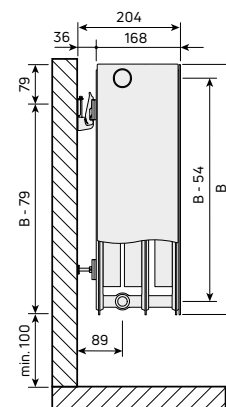

typ 33

rzut z przodu

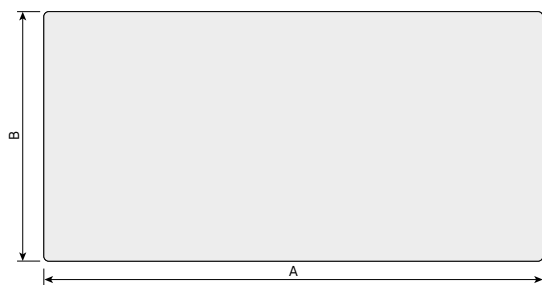

rzut z tyłu (typ 11)

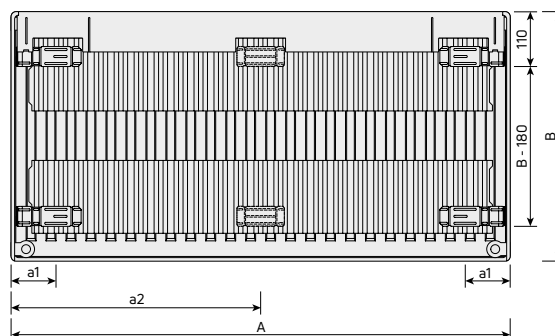

zalecane podłączenia

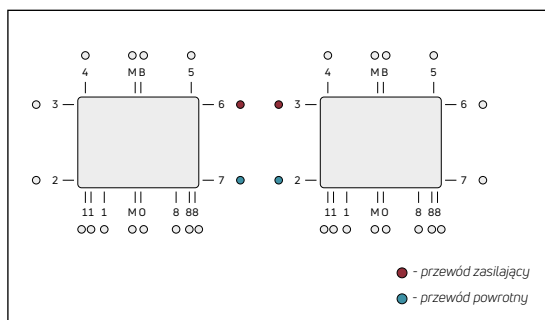

rzut z tyłu (typ 21s, 22, 33)

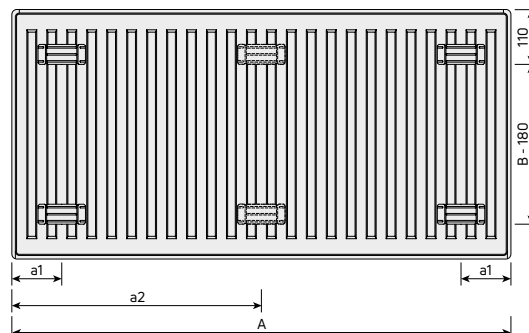

wymiary w [mm]; **A** = długość, **B** = wysokość

pojemność, ciężar i odległości montażowe

pojemność : l/m

wys. typ	300	400	500	600	900
11	2,0	2,6	3,3	3,7	5,1
21s	3,9	5,0	6,1	7,1	10,2
22	3,9	5,0	6,1	7,1	10,2
33	6,0	7,6	9,4	10,8	15,6

ciężar : kg/m

wys. typ	300	400	500	600	900
11	12,79	16,96	19,60	22,12	32,55
21s	17,78	23,53	27,85	32,02	47,65
22	20,83	28,02	32,38	36,60	54,53
33	29,76	40,07	46,14	51,97	77,42

odległości montażowe : mm

typ	11		21s, 22, 33	
A	a1	a2	a1	a2
400-1600	93	-	100	-
1800	93	900	100	900
2000	93	1000	100	1000
2200	93	1100	100	1100
2400	93	1200	100	1200
2600	93	1300	100	1300
2800	93	1400	100	1400
3000	93	1500	100	1500

długość [mm]		wysokość [mm]														
		300			400			500			600			900		
		moc [W]			moc [W]			moc [W]			moc [W]			moc [W]		
		75/65/20	70/55/20	55/45/20	75/65/20	70/55/20	55/45/20	75/65/20	70/55/20	55/45/20	75/65/20	70/55/20	55/45/20	75/65/20	70/55/20	55/45/20
		fabryczny nr katalogowy			fabryczny nr katalogowy			fabryczny nr katalogowy			fabryczny nr katalogowy			fabryczny nr katalogowy		
400		213	172	109	264	213	134	314	253	160	338	273	174	480	386	244
		FMP1103004010000			FMP1104004010000			FMP1105004010000			FMP1106004010000			FMP1109004010000		
520		277	224	141	343	277	175	408	329	209	439	355	226	623	502	317
		FMP1103005210000			FMP1104005210000			FMP1105005210000			FMP1106005210000			FMP1109005210000		
600		319	258	163	396	319	202	470	380	241	506	410	260	719	580	365
		FMP1103006010000			FMP1104006010000			FMP1105006010000			FMP1106006010000			FMP1109006010000		
720		383	310	196	475	383	242	564	456	289	608	492	312	863	696	438
		FMP1103007210000			FMP1104007210000			FMP1105007210000			FMP1106007210000			FMP1109007210000		
800		426	344	218	528	426	269	627	506	321	675	546	347	959	773	487
		FMP1103008010000			FMP1104008010000			FMP1105008010000			FMP1106008010000			FMP1109008010000		
920		489	396	250	607	489	309	721	582	369	776	628	399	1103	889	560
		FMP1103009210000			FMP1104009210000			FMP1105009210000			FMP1106009210000			FMP1109009210000		
1000		532	430	272	660	532	336	784	633	401	844	683	434	1199	966	609
		FMP1103010010000			FMP1104010010000			FMP1105010010000			FMP1106010010000			FMP1109010010000		
1120		596	482	305	739	596	376	878	709	449	945	765	486	1343	1082	682
		FMP1103011210000			FMP1104011210000			FMP1105011210000			FMP1106011210000			FMP1109011210000		
1200		638	516	326	792	638	403	941	760	481	1013	820	521	1439	1159	731
		FMP1103012010000			FMP1104012010000			FMP1105012010000			FMP1106012010000			FMP1109012010000		
1320		702	568	359	871	702	444	1035	836	529	1114	902	573	1583	1275	804
		FMP1103013210000			FMP1104013210000			FMP1105013210000			FMP1106013210000			FMP1109013210000		
1400		745	602	381	924	745	470	1098	886	561	1182	956	608	1679	1352	853
		FMP1103014010000			FMP1104014010000			FMP1105014010000			FMP1106014010000			FMP1109014010000		
1600		851	688	435	1056	851	538	1254	1013	642	1350	1093	694	1918	1546	974
		FMP1103016010000			FMP1104016010000			FMP1105016010000			FMP1106016010000			FMP1109016010000		
1800		958	774	490	1188	958	605	1411	1139	722	1519	1229	781	2158	1739	1096
		FMP1103018010000			FMP1104018010000			FMP1105018010000			FMP1106018010000			FMP1109018010000		
2000		1064	860	544	1320	1064	672	1568	1266	802	1688	1366	868	2398	1932	1218
		FMP1103020010000			FMP1104020010000			FMP1105020010000			FMP1106020010000			FMP1109020010000		
2200		1170	946	598	1452	1170	739	1725	1393	882	1857	1503	955	2638	2125	1340
		FMP1103022010000			FMP1104022010000			FMP1105022010000			FMP1106022010000			FMP1109022010000		
2400		1277	1032	653	1584	1277	806	1882	1519	962	2026	1639	1042	2878	2318	1462
		FMP1103024010000			FMP1104024010000			FMP1105024010000			FMP1106024010000			FMP1109024010000		
2600		1383	1118	707	1716	1383	874	2038	1646	1043	2194	1776	1128	3117	2512	1583
		FMP1103026010000			FMP1104026010000			FMP1105026010000			FMP1106026010000			FMP1109026010000		
2800		1490	1204	762	1848	1490	941	2195	1772	1123	2363	1912	1215	3357	2705	1705
		FMP1103028010000			FMP1104028010000			FMP1105028010000			FMP1106028010000			FMP1109028010000		
3000		1596	1290	816	1980	1596	1008	2352	1899	1203	2532	2049	1302	3597	2898	1827
		FMP1103030010000			FMP1104030010000			FMP1105030010000			FMP1106030010000			FMP1109030010000		

Uwaga! Widoczne fabryczne numery katalogowe dotyczą grzejnika z podłączeniem z boku w kolorze standardowym RAL9016, bez wkładki termostatycznej z nastawą wstępną. W przypadku grzejnika kolorowego numer katalogowy to FMP11..R lub S wraz z numerem danego koloru, np. FMP11..R9005.

[W/m]	676	840	996	1070	1527
90/70/20					
wykładnik n	1,3111	1,3211	1,3129	1,3031	1,3275

Moc cieplna grzejników [W] według normy PN-EN 442-2 dla parametrów 75/65/20 °C, 70/55/20 °C i 55/45/20 °C.

długość [mm]		wysokość [mm]														
		300			400			500			600			900		
		moc [W]			moc [W]			moc [W]			moc [W]			moc [W]		
		75/65/20	70/55/20	55/45/20	75/65/20	70/55/20	55/45/20	75/65/20	70/55/20	55/45/20	75/65/20	70/55/20	55/45/20	75/65/20	70/55/20	55/45/20
		fabryczny nr katalogowy			fabryczny nr katalogowy			fabryczny nr katalogowy			fabryczny nr katalogowy			fabryczny nr katalogowy		
400		313	252	159	395	318	201	469	380	242	520	421	268	708	570	359
		FMP2103004010000			FMP2104004010000			FMP2105004010000			FMP2106004010000			FMP2109004010000		
520		407	328	206	514	414	261	610	494	314	677	548	348	920	742	467
		FMP2103005210000			FMP2104005210000			FMP2105005210000			FMP2106005210000			FMP2109005210000		
600		470	379	238	593	478	301	704	570	362	781	632	401	1061	856	539
		FMP2103006010000			FMP2104006010000			FMP2105006010000			FMP2106006010000			FMP2109006010000		
720		564	454	286	711	573	361	845	684	435	937	758	482	1274	1027	647
		FMP2103007210000			FMP2104007210000			FMP2105007210000			FMP2106007210000			FMP2109007210000		
800		626	505	318	790	637	402	938	760	483	1041	842	535	1415	1141	718
		FMP2103008010000			FMP2104008010000			FMP2105008010000			FMP2106008010000			FMP2109008010000		
920		720	581	365	909	732	462	1079	874	556	1197	969	615	1627	1312	826
		FMP2103009210000			FMP2104009210000			FMP2105009210000			FMP2106009210000			FMP2109009210000		
1000		783	631	397	988	796	502	1173	950	604	1301	1053	669	1769	1426	898
		FMP2103010010000			FMP2104010010000			FMP2105010010000			FMP2106010010000			FMP2109010010000		
1120		877	707	445	1107	892	562	1314	1064	676	1457	1179	749	1981	1597	1006
		FMP2103011210000			FMP2104011210000			FMP2105011210000			FMP2106011210000			FMP2109011210000		
1200		940	757	476	1186	955	602	1408	1140	725	1561	1264	803	2123	1711	1078
		FMP2103012010000			FMP2104012010000			FMP2105012010000			FMP2106012010000			FMP2109012010000		
1320		1034	833	524	1304	1051	663	1548	1254	797	1717	1390	883	2335	1882	1185
		FMP2103013210000			FMP2104013210000			FMP2105013210000			FMP2106013210000			FMP2109013210000		
1400		1096	883	556	1383	1114	703	1642	1330	846	1821	1474	937	2477	1996	1257
		FMP2103014010000			FMP2104014010000			FMP2105014010000			FMP2106014010000			FMP2109014010000		
1600		1253	1010	635	1581	1274	803	1877	1520	966	2082	1685	1070	2830	2282	1437
		FMP2103016010000			FMP2104016010000			FMP2105016010000			FMP2106016010000			FMP2109016010000		
1800		1409	1136	715	1778	1433	904	2111	1710	1087	2342	1895	1204	3184	2567	1616
		FMP2103018010000			FMP2104018010000			FMP2105018010000			FMP2106018010000			FMP2109018010000		
2000		1566	1262	794	1976	1592	1004	2346	1900	1208	2602	2106	1338	3538	2852	1796
		FMP2103020010000			FMP2104020010000			FMP2105020010000			FMP2106020010000			FMP2109020010000		
2200		1723	1388	873	2174	1751	1104	2581	2090	1329	2862	2317	1472	3892	3137	1976
		FMP2103022010000			FMP2104022010000			FMP2105022010000			FMP2106022010000			FMP2109022010000		
2400		1879	1514	953	2371	1910	1205	2815	2280	1450	3122	2527	1606	4246	3422	2155
		FMP2103024010000			FMP2104024010000			FMP2105024010000			FMP2106024010000			FMP2109024010000		
2600		2036	1641	1032	2569	2070	1305	3050	2470	1570	3383	2738	1739	4599	3708	2335
		FMP2103026010000			FMP2104026010000			FMP2105026010000			FMP2106026010000			FMP2109026010000		
2800		2192	1767	1112	2766	2229	1406	3284	2660	1691	3643	2948	1873	4953	3993	2514
		FMP2103028010000			FMP2104028010000			FMP2105028010000			FMP2106028010000			FMP2109028010000		
3000		2349	1893	1191	2964	2388	1506	3519	2850	1812	3903	3159	2007	5307	4278	2694
		FMP2103030010000			FMP2104030010000			FMP2105030010000			FMP2106030010000			FMP2109030010000		

Uwaga! Widoczne fabryczne numery katalogowe dotyczą grzejnika z podłączeniem z boku w kolorze standardowym RAL9016, bez wkładki termostatycznej z nastawą wstępną. W przypadku grzejnika kolorowego numer katalogowy to FMP21..R lub S wraz z numerem danego koloru, np. FMP21..R9005.

[W/m]	997	1258	1487	1650	2253
90/70/20					
wykładnik n	1,3277	1,3265	1,2994	1,3022	1,3262

Moc cieplna grzejników [W] według normy PN-EN 442-2 dla parametrów 75/65/20 °C, 70/55/20 °C i 55/45/20 °C.

długość [mm]		wysokość [mm]														
		300			400			500			600			900		
		moc [W]			moc [W]			moc [W]			moc [W]			moc [W]		
		75/65/20	70/55/20	55/45/20	75/65/20	70/55/20	55/45/20	75/65/20	70/55/20	55/45/20	75/65/20	70/55/20	55/45/20	75/65/20	70/55/20	55/45/20
		fabryczny nr katalogowy			fabryczny nr katalogowy			fabryczny nr katalogowy			fabryczny nr katalogowy			fabryczny nr katalogowy		
400		428	346	220	534	431	271	608	490	310	668	537	337	899	722	452
		FMP2203004010000			FMP2204004010000			FMP2205004010000			FMP2206004010000			FMP2209004010000		
520		557	450	285	695	560	353	790	638	402	868	698	438	1169	939	587
		FMP2203005210000			FMP2204005210000			FMP2205005210000			FMP2206005210000			FMP2209005210000		
600		643	520	329	802	646	407	912	736	464	1001	806	506	1349	1084	677
		FMP2203006010000			FMP2204006010000			FMP2205006010000			FMP2206006010000			FMP2209006010000		
720		771	624	395	962	775	488	1094	883	557	1202	967	607	1619	1300	813
		FMP2203007210000			FMP2204007210000			FMP2205007210000			FMP2206007210000			FMP2209007210000		
800		857	693	439	1069	862	542	1216	981	619	1335	1074	674	1798	1445	903
		FMP2203008010000			FMP2204008010000			FMP2205008010000			FMP2206008010000			FMP2209008010000		
920		985	797	505	1229	991	624	1398	1128	712	1535	1236	776	2068	1662	1039
		FMP2203009210000			FMP2204009210000			FMP2205009210000			FMP2206009210000			FMP2209009210000		
1000		1071	866	549	1336	1077	678	1520	1226	774	1669	1343	843	2248	1806	1129
		FMP2203010010000			FMP2204010010000			FMP2205010010000			FMP2206010010000			FMP2209010010000		
1120		1200	970	615	1496	1206	759	1702	1373	867	1869	1504	944	2518	2023	1264
		FMP2203011210000			FMP2204011210000			FMP2205011210000			FMP2206011210000			FMP2209011210000		
1200		1285	1039	659	1603	1292	814	1824	1471	929	2003	1612	1012	2698	2167	1355
		FMP2203012010000			FMP2204012010000			FMP2205012010000			FMP2206012010000			FMP2209012010000		
1320		1414	1143	725	1764	1422	895	2006	1618	1022	2203	1773	1113	2967	2384	1490
		FMP2203013210000			FMP2204013210000			FMP2205013210000			FMP2206013210000			FMP2209013210000		
1400		1499	1212	769	1870	1508	949	2128	1716	1084	2337	1880	1180	3147	2528	1581
		FMP2203014010000			FMP2204014010000			FMP2205014010000			FMP2206014010000			FMP2209014010000		
1600		1714	1386	878	2138	1723	1085	2432	1962	1238	2670	2149	1349	3597	2890	1806
		FMP2203016010000			FMP2204016010000			FMP2205016010000			FMP2206016010000			FMP2209016010000		
1800		1928	1559	988	2405	1939	1220	2736	2207	1393	3004	2417	1517	4046	3251	2032
		FMP2203018010000			FMP2204018010000			FMP2205018010000			FMP2206018010000			FMP2209018010000		
2000		2142	1732	1098	2672	2154	1356	3040	2452	1548	3338	2686	1686	4496	3612	2258
		FMP2203020010000			FMP2204020010000			FMP2205020010000			FMP2206020010000			FMP2209020010000		
2200		2356	1905	1208	2939	2369	1492	3344	2697	1703	3672	2955	1855	4946	3973	2484
		FMP2203022010000			FMP2204022010000			FMP2205022010000			FMP2206022010000			FMP2209022010000		
2400		2570	2078	1318	3206	2585	1627	3648	2942	1858	4006	3223	2023	5395	4334	2710
		FMP2203024010000			FMP2204024010000			FMP2205024010000			FMP2206024010000			FMP2209024010000		
2600		2785	2252	1427	3474	2800	1763	3952	3188	2012	4339	3492	2192	5845	4696	2935
		FMP2203026010000			FMP2204026010000			FMP2205026010000			FMP2206026010000			FMP2209026010000		
2800		2999	2425	1537	3741	3016	1898	4256	3433	2167	4673	3760	2360	6294	5057	3161
		FMP2203028010000			FMP2204028010000			FMP2205028010000			FMP2206028010000			FMP2209028010000		
3000		3213	2598	1647	4008	3231	2034	4560	3678	2322	5007	4029	2529	6744	5418	3387
		FMP2203030010000			FMP2204030010000			FMP2205030010000			FMP2206030010000			FMP2209030010000		

Uwaga! Widoczne fabryczne numery katalogowe dotyczą grzejnika z podłączeniem z boku w kolorze standardowym RAL9016, bez wkładki termostatycznej z nastawą wstępną. W przypadku grzejnika kolorowego numer katalogowy to FMP22..R lub S wraz z numerem danego koloru, np. FMP22..R9005.

[W/m]	1359	1702	1934	2130	2875
90/70/20					
wykładnik n	1,3081	1,3281	1,3220	1,3371	1,3487

Moc cieplna grzejników [W] według normy PN-EN 442-2 dla parametrów 75/65/20 °C, 70/55/20 °C i 55/45/20 °C.

długość [mm]		wysokość [mm]														
		300			400			500			600			900		
		moc [W]			moc [W]			moc [W]			moc [W]			moc [W]		
		75/65/20	70/55/20	55/45/20	75/65/20	70/55/20	55/45/20	75/65/20	70/55/20	55/45/20	75/65/20	70/55/20	55/45/20	75/65/20	70/55/20	55/45/20
		fabryczny nr katalogowy			fabryczny nr katalogowy			fabryczny nr katalogowy			fabryczny nr katalogowy			fabryczny nr katalogowy		
400		626	506	320	778	626	392	857	690	435	967	779	490	1264	1017	638
		FMP3303004010000			FMP3304004010000			FMP3305004010000			FMP3306004010000			FMP3309004010000		
520		814	658	417	1012	814	510	1114	898	565	1257	1012	636	1643	1322	830
		FMP3303005210000			FMP3304005210000			FMP3305005210000			FMP3306005210000			FMP3309005210000		
600		940	759	481	1168	939	588	1285	1036	652	1451	1168	734	1895	1525	958
		FMP3303006010000			FMP3304006010000			FMP3305006010000			FMP3306006010000			FMP3309006010000		
720		1128	911	577	1401	1127	706	1542	1243	783	1741	1402	881	2274	1830	1149
		FMP3303007210000			FMP3304007210000			FMP3305007210000			FMP3306007210000			FMP3309007210000		
800		1253	1012	641	1557	1252	784	1714	1381	870	1934	1558	979	2527	2034	1277
		FMP3303008010000			FMP3304008010000			FMP3305008010000			FMP3306008010000			FMP3309008010000		
920		1441	1164	737	1790	1440	902	1971	1588	1000	2225	1791	1126	2906	2339	1468
		FMP3303009210000			FMP3304009210000			FMP3305009210000			FMP3306009210000			FMP3309009210000		
1000		1566	1265	801	1946	1565	980	2142	1726	1087	2418	1947	1224	3159	2542	1596
		FMP3303010010000			FMP3304010010000			FMP3305010010000			FMP3306010010000			FMP3309010010000		
1120		1754	1417	897	2180	1753	1098	2399	1933	1217	2708	2181	1371	3538	2847	1788
		FMP3303011210000			FMP3304011210000			FMP3305011210000			FMP3306011210000			FMP3309011210000		
1200		1879	1518	961	2335	1878	1176	2570	2071	1304	2902	2336	1469	3791	3050	1915
		FMP3303012010000			FMP3304012010000			FMP3305012010000			FMP3306012010000			FMP3309012010000		
1320		2067	1670	1057	2569	2066	1294	2827	2278	1435	3192	2570	1616	4170	3355	2107
		FMP3303013210000			FMP3304013210000			FMP3305013210000			FMP3306013210000			FMP3309013210000		
1400		2192	1771	1121	2724	2191	1372	2999	2416	1522	3385	2726	1714	4423	3559	2234
		FMP3303014010000			FMP3304014010000			FMP3305014010000			FMP3306014010000			FMP3309014010000		
1600		2506	2024	1282	3114	2504	1568	3427	2762	1739	3869	3115	1958	5054	4067	2554
		FMP3303016010000			FMP3304016010000			FMP3305016010000			FMP3306016010000			FMP3309016010000		
1800		2819	2277	1442	3503	2817	1764	3856	3107	1957	4352	3505	2203	5686	4576	2873
		FMP3303018010000			FMP3304018010000			FMP3305018010000			FMP3306018010000			FMP3309018010000		
2000		3132	2530	1602	3892	3130	1960	4284	3452	2174	4836	3894	2448	6318	5084	3192
		FMP3303020010000			FMP3304020010000			FMP3305020010000			FMP3306020010000			FMP3309020010000		
2200		3445	2783	1762	4281	3443	2156	4712	3797	2391	5320	4283	2693	6950	5592	3511
		FMP3303022010000			FMP3304022010000			FMP3305022010000			FMP3306022010000			FMP3309022010000		
2400		3758	3036	1922	4670	3756	2352	5141	4142	2609	5803	4673	2938	7582	6101	3830
		FMP3303024010000			FMP3304024010000			FMP3305024010000			FMP3306024010000			FMP3309024010000		
2600		4072	3289	2083	5060	4069	2548	5569	4488	2826	6287	5062	3182	8213	6609	4150
		FMP3303026010000			FMP3304026010000			FMP3305026010000			FMP3306026010000			FMP3309026010000		
2800		4385	3542	2243	5449	4382	2744	5998	4833	3044	6770	5452	3427	8845	7118	4469
		FMP3303028010000			FMP3304028010000			FMP3305028010000			FMP3306028010000			FMP3309028010000		
3000		4698	3795	2403	5838	4695	2940	6426	5178	3261	7254	5841	3672	9477	7626	4788
		FMP3303030010000			FMP3304030010000			FMP3305030010000			FMP3306030010000			FMP3309030010000		

Uwaga! Widoczne fabryczne numery katalogowe dotyczą grzejnika z podłączeniem z boku w kolorze standardowym RAL9016, bez wkładki termostatycznej z nastawą wstępną. W przypadku grzejnika kolorowego numer katalogowy to FMP33..R lub S wraz z numerem danego koloru, np. FMP33..R9005.

[W/m]	1990	2486	2728	3083	4030
90/70/20					
wykładnik n	1,3136	1,3422	1,3270	1,3334	1,3361

Moc cieplna grzejników [W] według normy PN-EN 442-2 dla parametrów 75/65/20 °C, 70/55/20 °C i 55/45/20 °C.

Współczynniki przeliczeniowe mocy grzejników

Tz	Ti	Tp 25	30	35	40	45	50	55	60	65	70	75	80	85
90	24	4,56	2,45	1,88	1,57	1,36	1,21	1,10	1,01	0,93	0,87	0,82	0,77	0,73
	22	3,11	2,11	1,69	1,44	1,27	1,14	1,04	0,96	0,89	0,83	0,78	0,74	0,70
	20	2,50	1,87	1,54	1,33	1,19	1,07	0,98	0,91	0,85	0,80	0,75	0,71	0,67
	18	2,13	1,68	1,42	1,24	1,11	1,01	0,93	0,87	0,81	0,76	0,72	0,68	0,65
	15	1,76	1,46	1,26	1,13	1,02	0,93	0,87	0,81	0,76	0,72	0,68	0,64	0,61
	12	1,51	1,29	1,14	1,03	0,94	0,87	0,81	0,76	0,71	0,67	0,64	0,61	0,58
85	24	1,93	2,63	2,00	1,67	1,45	1,29	1,16	1,07	0,99	0,92	0,86	0,81	
	22	3,34	2,26	1,80	1,53	1,34	1,21	1,10	1,01	0,94	0,88	0,82	0,78	
	20	2,67	1,99	1,64	1,41	1,25	1,13	1,04	0,96	0,89	0,84	0,79	0,75	
	18	2,27	1,78	1,50	1,31	1,18	1,07	0,98	0,91	0,85	0,80	0,75	0,72	
	15	1,87	1,54	1,33	1,19	1,07	0,98	0,91	0,85	0,80	0,75	0,71	0,67	
	12	1,60	1,36	1,20	1,08	0,99	0,91	0,85	0,79	0,75	0,70	0,67	0,64	
80	24	5,38	2,83	2,15	1,78	1,54	1,37	1,24	1,13	1,05	0,97	0,91		
	22	3,61	2,42	1,93	1,63	1,43	1,28	1,16	1,07	0,99	0,93	0,87		
	20	2,87	2,12	1,75	1,50	1,33	1,20	1,10	1,01	0,94	0,88	0,83		
	18	2,42	1,90	1,60	1,39	1,24	1,13	1,04	0,96	0,90	0,84	0,79		
	15	1,99	1,64	1,41	1,25	1,13	1,04	0,96	0,89	0,84	0,79	0,75		
	12	1,69	1,44	1,27	1,14	1,04	0,96	0,89	0,83	0,78	0,74	0,70		
75	24	5,90	3,07	2,32	1,92	1,66	1,47	1,32	1,21	1,12	1,04			
	22	3,92	2,61	2,07	1,75	1,53	1,37	1,24	1,14	1,05	0,98			
	20	3,10	2,28	1,87	1,61	1,42	1,28	1,17	1,08	1,00	0,94			
	18	2,61	2,03	1,70	1,48	1,32	1,20	1,10	1,02	0,95	0,89			
	15	2,12	1,75	1,50	1,33	1,20	1,10	1,01	0,94	0,88	0,83			
	12	1,80	1,53	1,34	1,21	1,10	1,01	0,94	0,88	0,82	0,78			
70	24	6,54	3,36	2,52	2,08	1,79	1,58	1,42	1,30	1,19				
	22	4,30	2,84	2,24	1,89	1,64	1,47	1,33	1,22	1,13				
	20	3,38	2,47	2,01	1,73	1,52	1,37	1,25	1,15	1,07				
	18	2,82	2,19	1,83	1,59	1,42	1,28	1,17	1,08	1,01				
	15	2,28	1,87	1,61	1,42	1,28	1,17	1,08	1,00	0,94				
	12	1,93	1,63	1,43	1,28	1,16	1,07	0,99	0,93	0,87				
65	24	7,32	3,70	2,76	2,27	1,94	1,71	1,54	1,40					
	22	4,75	3,11	2,44	2,05	1,78	1,58	1,43	1,31					
	20	3,70	2,69	2,19	1,87	1,64	1,47	1,34	1,23					
	18	3,07	2,37	1,98	1,17	1,52	1,37	1,26	1,16					
	15	2,47	2,01	1,73	1,52	1,37	1,25	1,15	1,07					
	12	2,07	1,75	1,53	1,37	1,24	1,14	1,05	0,98					
60	24	8,32	4,13	3,06	2,50	2,13	1,87	1,68						
	22	5,32	3,44	2,69	2,24	1,94	1,73	1,56						
	20	4,10	2,96	2,39	2,03	1,78	1,60	1,45						
	18	3,38	2,59	2,15	1,86	1,65	1,48	1,35						
	15	2,69	2,19	1,87	1,64	1,47	1,34	1,23						
	12	2,24	1,89	1,64	1,47	1,33	1,22	1,13						
55	24	9,62	4,67	3,43	2,78	2,37	2,07							
	22	6,03	3,87	2,99	2,48	2,15	1,90							
	20	4,60	3,29	2,64	2,24	1,96	1,75							
	18	3,75	2,86	2,36	2,03	1,80	1,62							
	15	2,96	2,39	2,03	1,78	1,60	1,45							
	12	2,44	2,05	1,78	1,58	1,43	1,31							
50	24	11,38	5,39	3,92	3,15	2,67								
	22	6,97	4,39	3,37	2,79	2,40								
	20	5,23	3,70	2,96	2,50	2,17								
	18	4,22	3,19	2,63	2,25	1,98								
	15	3,29	2,64	2,24	1,96	1,75								
	12	2,69	2,24	1,94	1,73	1,56								
45	24	13,93	6,38	4,58	3,65									
	22	8,26	5,11	3,89	3,19									
	20	6,08	4,25	3,37	2,83									
	18	4,84	3,63	2,96	2,53									
	15	3,70	2,96	2,50	2,17									
	12	2,99	2,48	2,15	1,90									
40	24	17,93	7,87	5,54										
	22	10,16	6,14	4,62										
	20	7,28	5,01	3,93										
	18	5,68	4,21	3,41										
	15	4,25	3,37	2,83										
	12	3,37	2,79	2,40										
35	24	25,15	10,36											
	22	13,27	7,76											
	20	9,12	6,14											
	18	6,91	5,04											
	15	5,01	3,93											
	12	3,89	3,19											
30	24	42,40												
	22	19,37												
	20	12,34												
	18	8,89												
	15	6,14												
	12	4,62												

współczynniki obliczone dla wykładnika n = 1.3

Tz : temp. zasilania (°C)

Ti : temp. otoczenia (°C)

Tp : temp. powrotu (°C)

opis



zestaw zawieszń SSMS do grzejników płytowych z uchwytami o wysokości 300 - 900 mm:

Odległość grzejnika od ściany – 30 mm.
Maksymalne obciążenie pojedynczego zawieszania:
pionowo – 120 kg
wyrywanie – 60 kg

grzejnik płytowy długość mm	ilość zawieszń
400 - 1600	2
1800 - 3000	3

W komplecie z określonym typem grzejnika

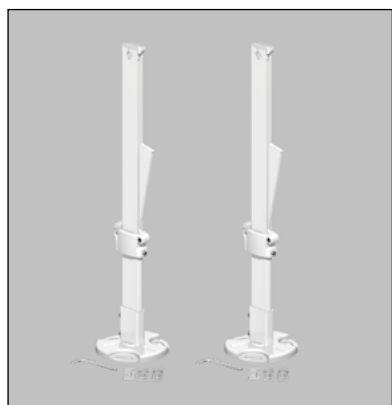

stojak podłogowy do grzejników płytowych typu 21s, 22, 33 o wysokości 300 - 900 mm:

Odległość grzejnika od ściany dowolna.
Maksymalne obciążenie pojedynczego stojaka:
pionowo – 180 kg
wyrywanie – 35 kg
kod zamówienia: **AZ02BS1WEM817H01** (1 szt.)

wysokość 300 - 600 mm		wysokość 900 mm	
grzejnik płytowy długość mm	ilość stojaków	grzejnik płytowy długość mm	ilość stojaków
400 - 1800	2	400 - 1200	2
2000 - 2300	3	1400 - 1800	3
2600 - 3000	4	2000 - 3000	4

Paleta kolorów Purmo Group

KOLOR STANDARDOWY

RAL 9016 Traffic white

KOLORY RAL

RAL 1004 Golden yellow	RAL 1012 Lemon yellow	RAL 1023 Traffic yellow	RAL 1027 Curry yellow	RAL 1033 Dahlia yellow	RAL 2003 Pastel orange	RAL 2004 Pure orange	RAL 3000 Flame red
RAL 3005 Wine red	RAL 3014 Antique pink	RAL 3015 Light pink	RAL 4002 Red violet	RAL 4007 Purple violet	RAL 4008 Signal violet	RAL 4009 Pastel violet	RAL 5001 Green blue
RAL 5002 Ultramarine blue	RAL 5009 Azure blue	RAL 5014 Pigeon blue	RAL 5015 Sky blue	RAL 5017 Traffic blue	RAL 5022 Night blue	RAL 6004 Blue green	RAL 6019 Pastel green
RAL 6033 Mint turquoise	RAL 6034 Pastel turquoise	RAL 7001 Silver grey	RAL 7013 Brown grey	RAL 7015 Slate grey	RAL 7016 Anthracite grey	RAL 7021 Black grey	RAL 7024 Graphite grey
RAL 7030 Stone grey	RAL 7035 Light grey	RAL 7037 Dusty grey	RAL 7040 Window grey	RAL 8017 Chocolate brown	RAL 8019 Grey brown	RAL 9001 Cream	RAL 9005 Jet black
RAL 9006 White aluminium	RAL 9007 Grey aluminium	RAL 9010 Pure White	RAL 040 80 05 Caffé Latte (S0222)	RAL 120 70 70 E-Green (S0221)	RAL 120 80 60 Modern green (S0220)	RAL 150 60 60 Green Apple (S0219)	RAL 250-2 Lemon Glow (S0182)
RAL 290 40 45 Mystic Purple (S0185)	RAL 290 70 20 Maue Haze (S0178)						

KOLORY SPECJALNE

S0075 Jasmine	S0077 Magnolia	S0084 Anemone	S0087 Bahama beige	S0088 Manhattan	S0091 Pergamon	S0094 Natura	S0164 Banana
S0102 Metal Grey ²	S0104 Metal Black ²	S0141 Black Textured ¹	S0142 White Textured ¹	S0143 Light Grey	S0144 Brown Grey	S0145 Creme White	S0146 Anodic Bronze
S0147 Anodic Brown	S0148 Anodic Black	S0149 Anodic Natura	S0201 Metal Alu ²				

¹ kolor strukturalny

² kolor metaliczny

Prezentowane w folderze kolory należy traktować jako poglądowe. Przed zakupem należy dobierać kolory tylko na podstawie oryginalnego wzornika kolorów. Producent nie bierze odpowiedzialności za dobór kolorów na podstawie materiałów drukowanych bądź wyświetlonych na ekranie komputera.

UWAGA! Różne typy grzejników mogą mieć różne odcienie tego samego koloru.

PURMO GROUP POLAND SP. Z O.O.

02-777 Warszawa
ul. Ciszewskiego 15
budynek KEN Center
tel. (22) 544 10 00
info@radson.pl
www.radson.pl

